

INSTALLATION MANUAL

1. Install the support bar ,adjust the 4 position ,and tighten it.

Attention:Do not use any corrosion liquid to clean the aluminum and other metal parts when daily maintenance.

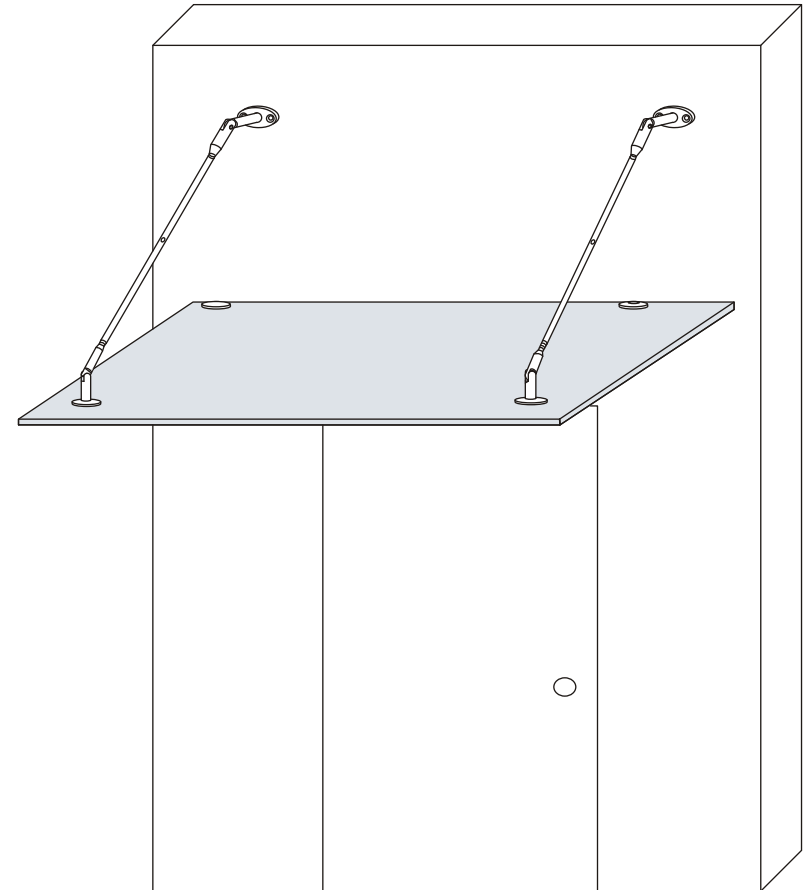
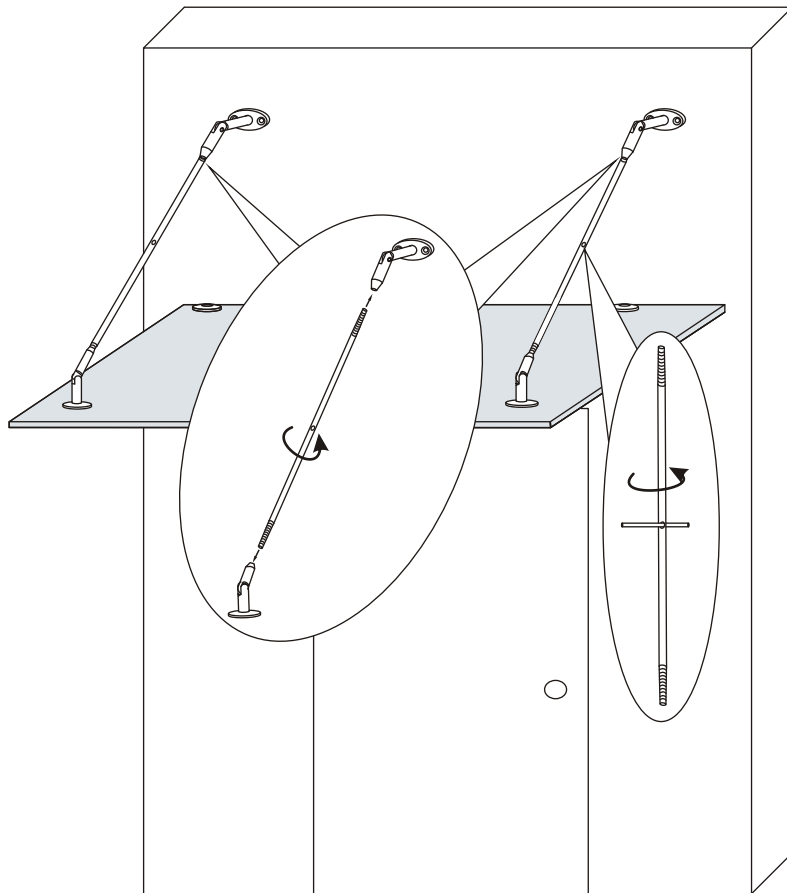
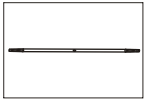

TP-001

RoHS  **ISO9001:2000**

TOOL PICTURE

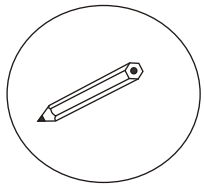

Pencil

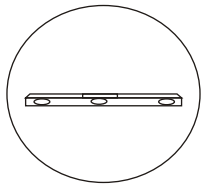

Level ruler

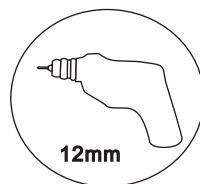

Drill machine

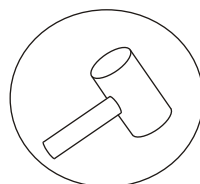

Rubber hammer

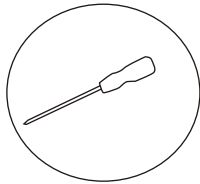

Cross screw driver

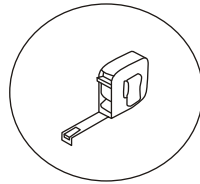

Tape

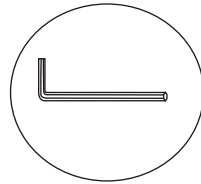

Allen wrench
(In the package)

Accessory list

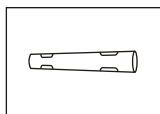

PJ-4044

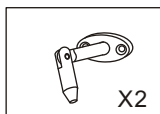

PJ-4014

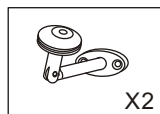

PJ-4015

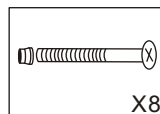

PJ-4024

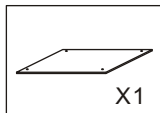

Glass

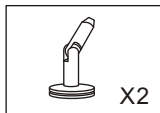

PJ-4013

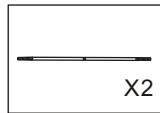

LG-2007

1. Place the glass, fixed by the allen wrench

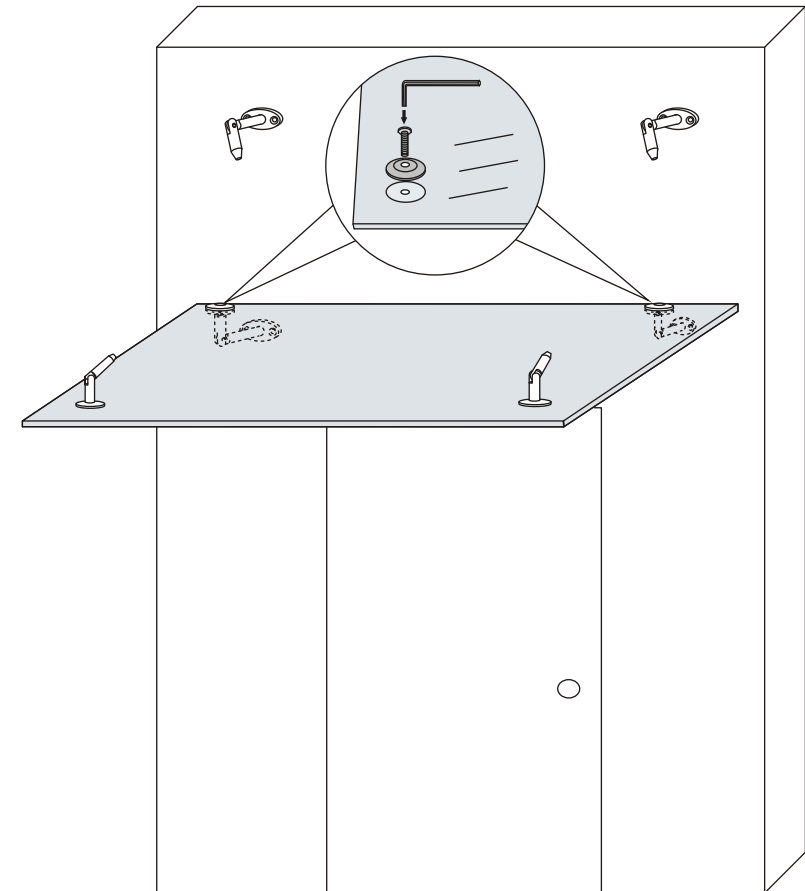
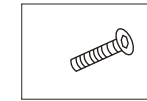
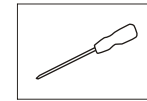
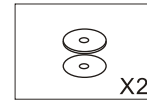

1. Install the hanger fix part ,fixed by the allen wrench

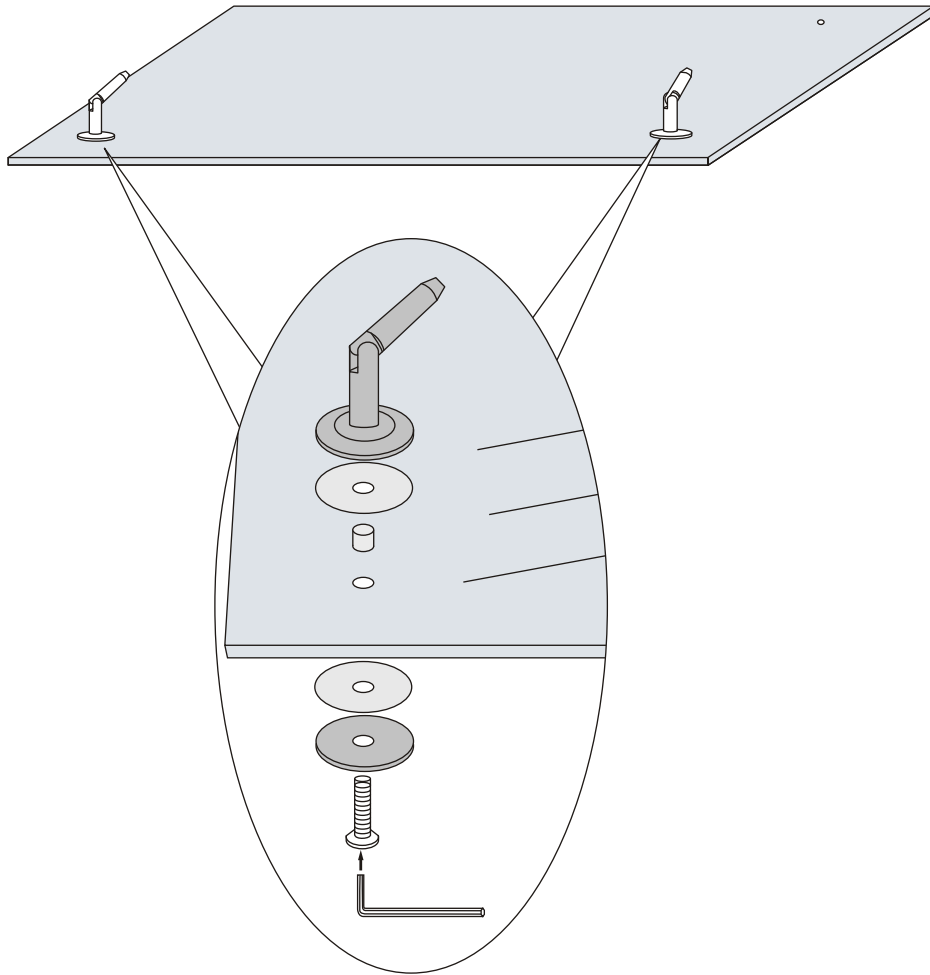
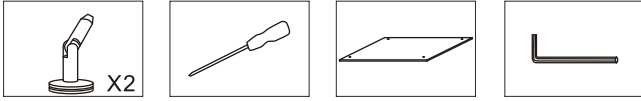

4

1.As the picture show,make a mark by pencil ,Use tape to measure the distance,ensure it flat by lever ruler.

The total length of the glass	A	B
1500mm	1320mm	550mm
1800mm	1620mm	550mm
2000mm	1600mm	550mm

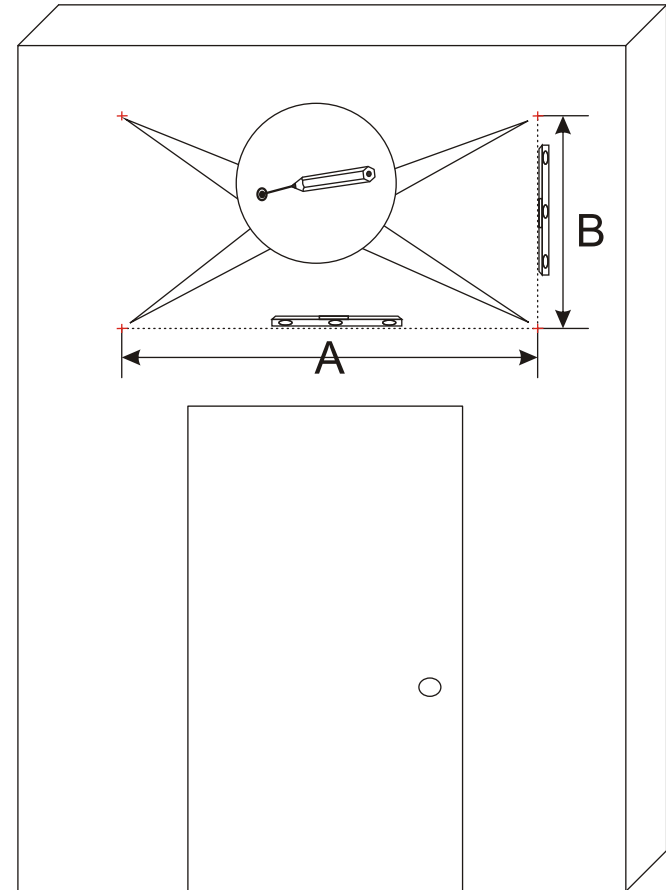
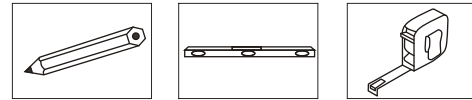

1

1. Make the mark to fixed 8 positions, C=2.5CM
2. Drill hole on the fixed position

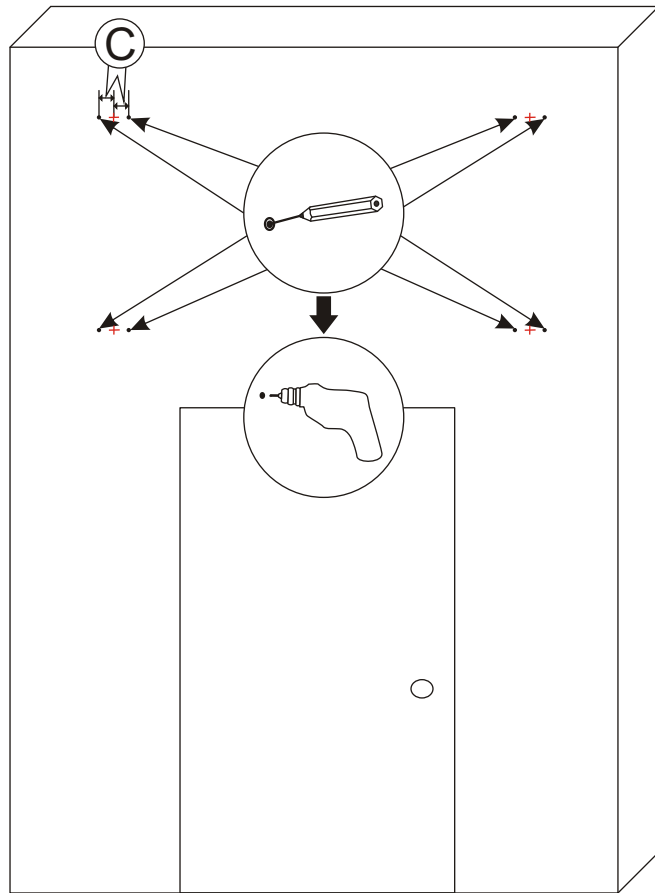
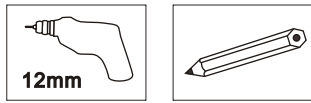

2

1. Install the fixed part, tighten the screws to fix it.

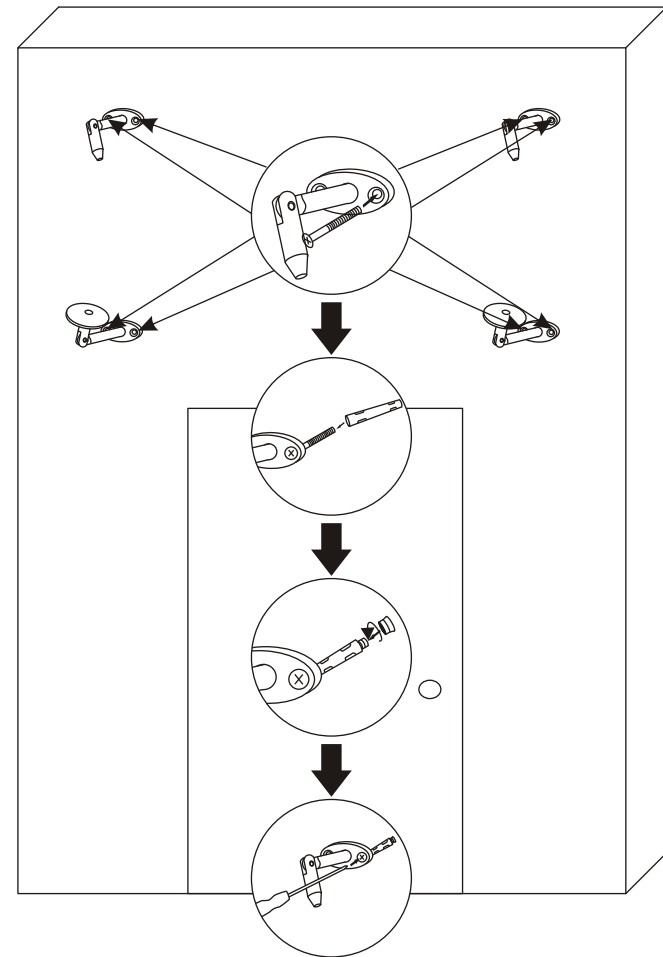
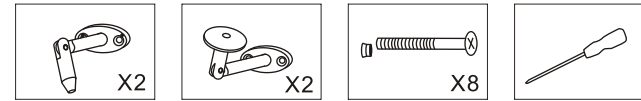

3